



US00D690742S

(12) **United States Design Patent**
Sussman

(10) **Patent No.:** **US D690,742 S**

(45) **Date of Patent:** **** Oct. 1, 2013**

(54) **DECORATIVE FURNITURE FREEZER**

(57) **CLAIM**

(76) Inventor: **Seymour Sussman**, Manchester, NJ
(US)

The ornamental design for a decorative furniture freezer, as shown and described.

(**) Term: **14 Years**

DESCRIPTION

(21) Appl. No.: **29/422,269**

FIG. 1 is a front isometric view for a decorative furniture freezer with the lid shown in a closed position;

(22) Filed: **May 18, 2012**

FIG. 2 is an enlarged upper left front fragmented isometric view thereof;

(51) **LOC (9) CL.** **15-07**

FIG. 3 is an enlarged upper right front fragmented isometric view thereof;

(52) **U.S. CL.**

USPC **D15/81**

FIG. 4 is an enlarged left door isometric view thereof;

(58) **Field of Classification Search**

USPC D15/79, 81, 83, 85, 88; 62/3.1, 3.6,

62/3.63, 3.64, 389-400, 440, 441, 457.1,

62/258, 329; 312/116, 226, 352, 400-408;

D6/335, 336, 396, 432, 440, 448, 455, 470

See application file for complete search history.

FIG. 5 is an enlarged right door isometric view thereof;

FIG. 6 is an enlarged lower front fragmented isometric view thereof;

FIG. 7 is a front elevational view of FIG. 1;

FIG. 8 is an enlarged front elevational view of FIG. 2;

FIG. 9 is an enlarged front elevational view of FIG. 3;

FIG. 10 is an enlarged front elevational view of FIG. 4;

FIG. 11 is an enlarged front elevational view of FIG. 5;

FIG. 12 is an enlarged front elevational view of FIG. 6;

FIG. 13 is a rear isometric view of FIG. 1;

FIG. 14 is a rear elevational view of FIG. 13;

FIG. 15 is an enlarged right side elevational view of FIG. 1;

FIG. 16 is an enlarged top plan view of FIG. 1;

FIG. 17 is an enlarged bottom plan view of FIG. 1;

FIG. 18 is a front isometric view for a decorative furniture freezer with the lid shown in an open position;

FIG. 19 is an enlarged isometric view of the lid of FIG. 18;

FIG. 20 is a front elevational view of FIG. 18;

FIG. 21 is a right side view of FIG. 20; and,

FIG. 22 is a top plan view of FIG. 18.

The broken line showing is included for the purpose of illustrating and forms no part of the claimed design.

(56) **References Cited**

U.S. PATENT DOCUMENTS

D33,348 S *	10/1900	Vanderlinda	D15/88
D63,814 S *	1/1924	Banta	D15/85
D66,396 S *	1/1925	Banta	D15/85
D68,859 S *	11/1925	Hornung	D15/81
2,149,114 A *	2/1939	Constantine	62/377
2,554,290 A *	5/1951	Becker	62/329
D168,603 S *	1/1953	Tell	D6/440
2,743,981 A *	5/1956	Moore	312/401
D199,826 S *	12/1964	Reichow	D15/83
D217,074 S *	3/1970	Jones	D15/83

(Continued)

Primary Examiner — Mitchell Siegel

(74) *Attorney, Agent, or Firm* — Ash Tankha; Lipton, Weinberger & Husick

1 Claim, 22 Drawing Sheets

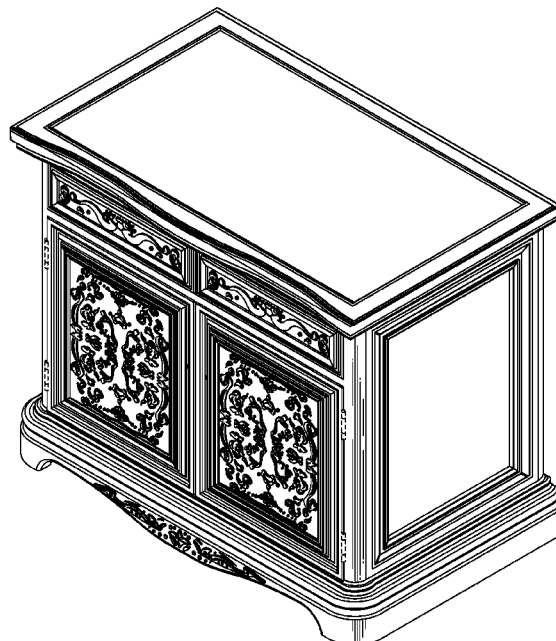

(56)

References Cited

U.S. PATENT DOCUMENTS

4,400,951 A * 8/1983 Cherry 62/258
D358,823 S * 5/1995 Grant D15/83
5,671,991 A * 9/1997 Grant 312/406

D501,489 S * 2/2005 Seo et al. D15/83
D551,259 S * 9/2007 Wilson D15/79
D652,434 S * 1/2012 Sun et al. D15/83
D672,793 S * 12/2012 Tang et al. D15/83
2005/0189852 A1* 9/2005 Dearo et al. 312/204

* cited by examiner

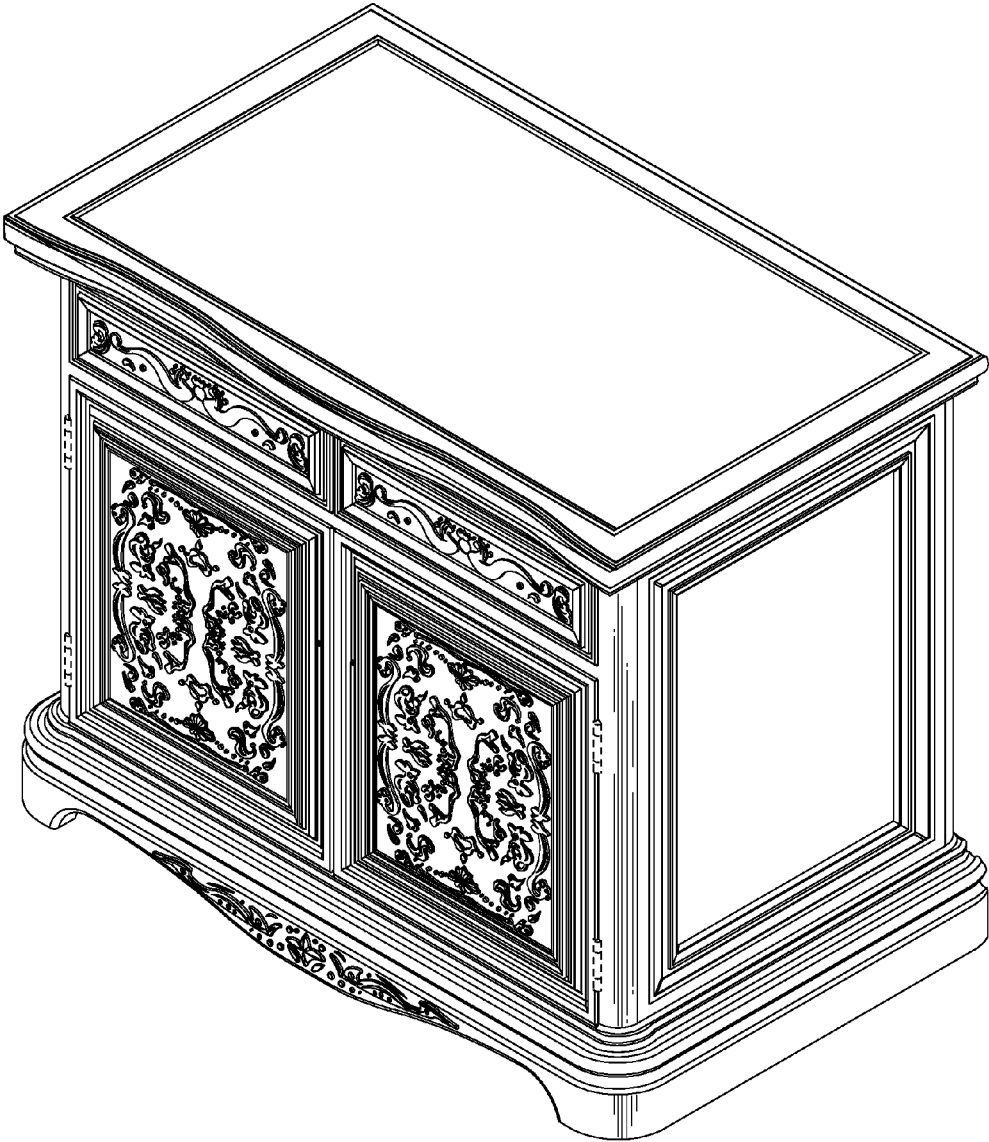

FIG. 1

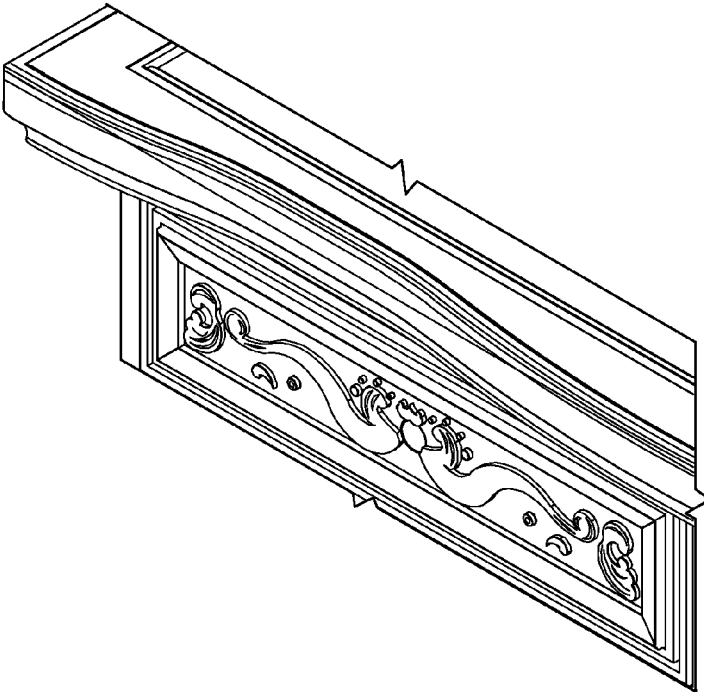

FIG. 2

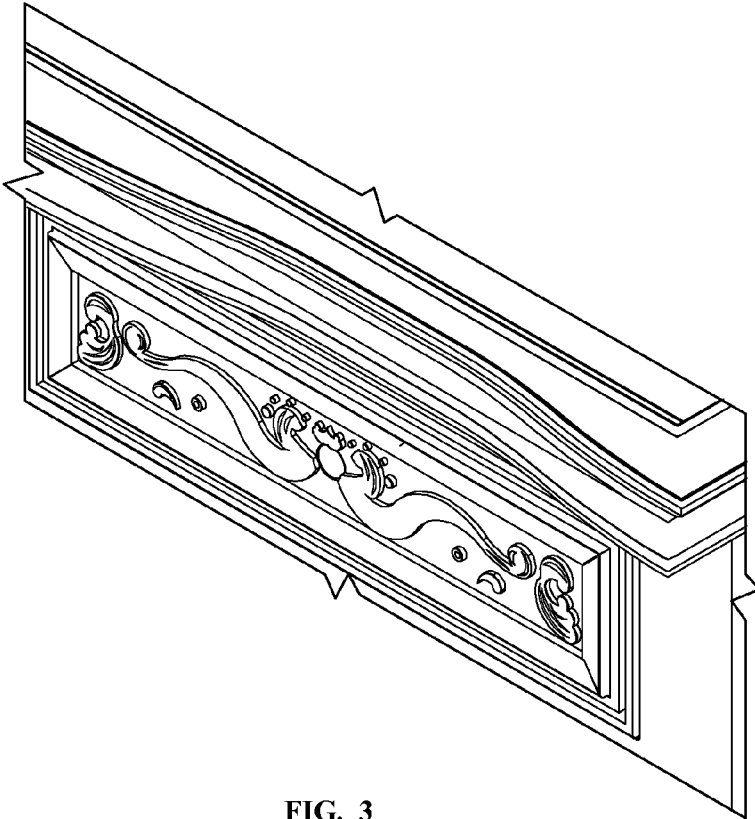

FIG. 3

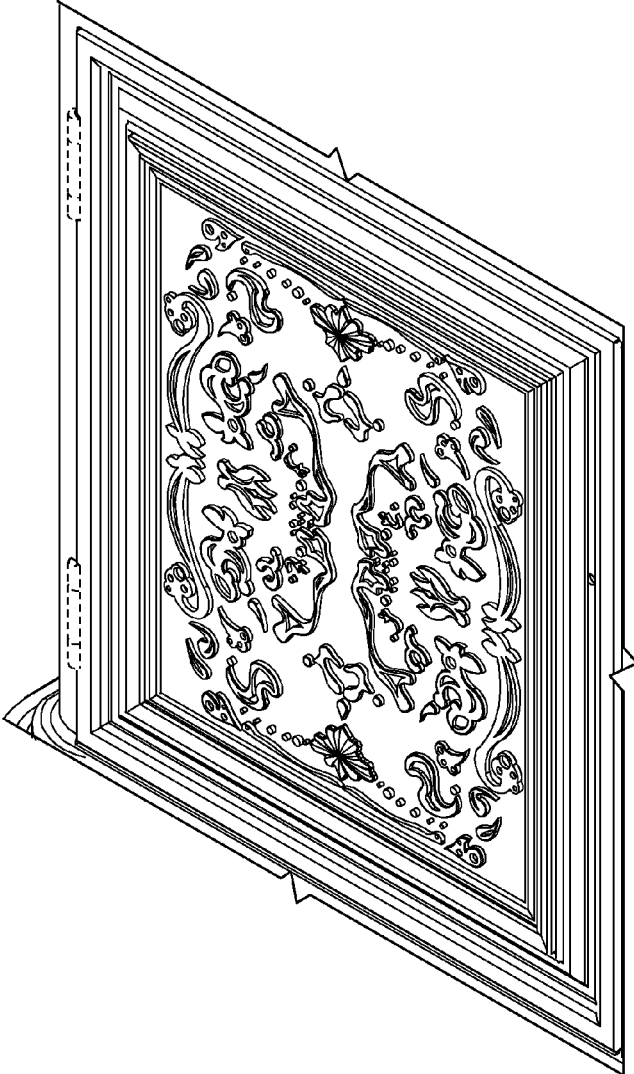

FIG. 4

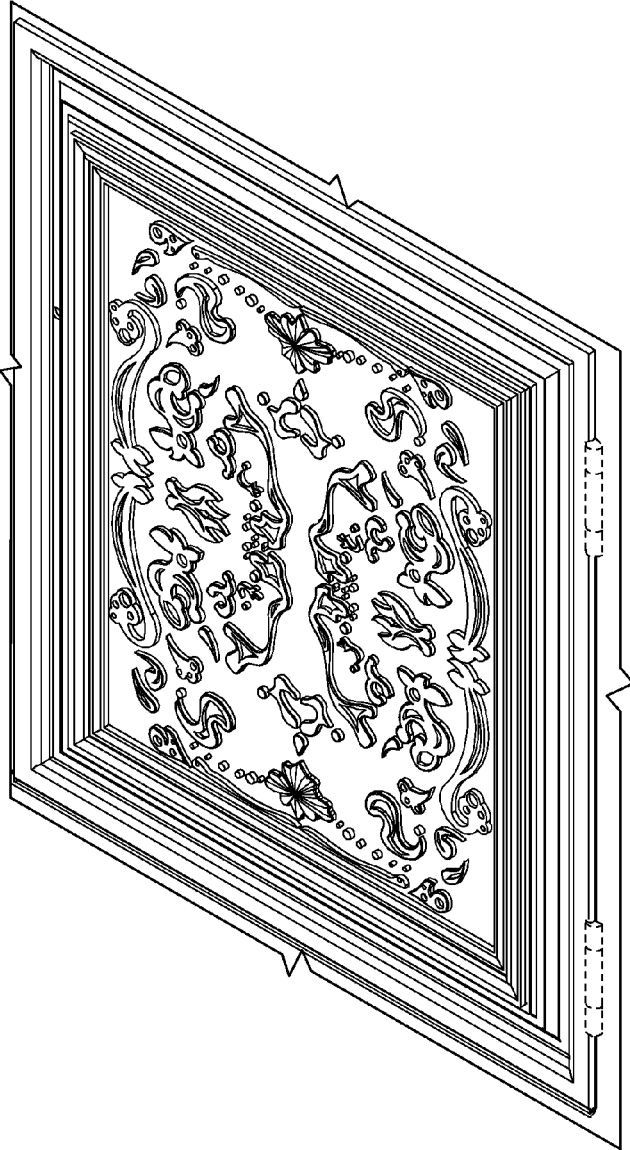

FIG. 5

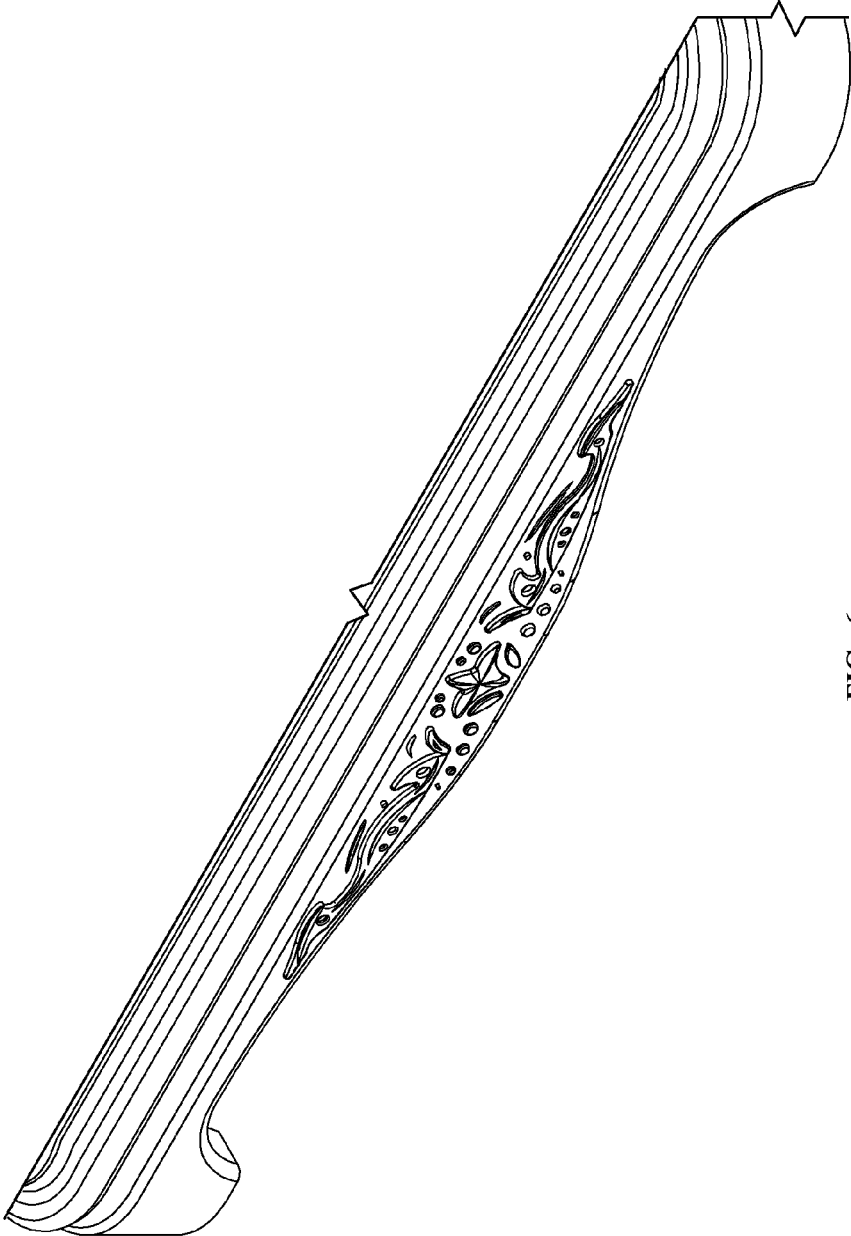

FIG. 6

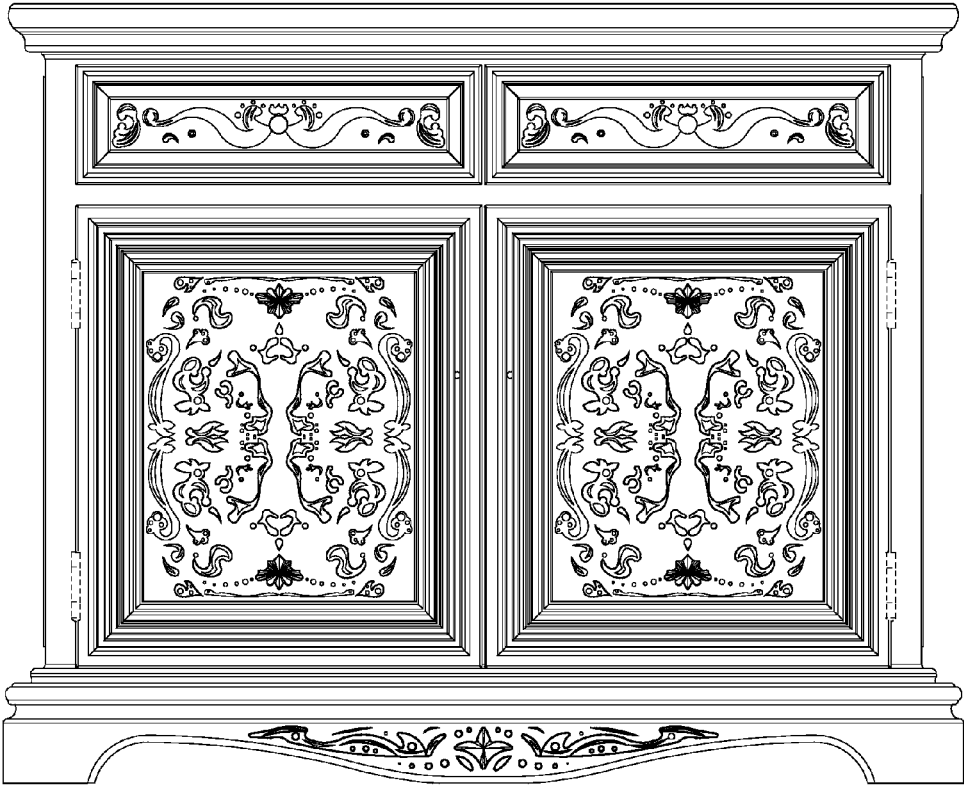

FIG. 7

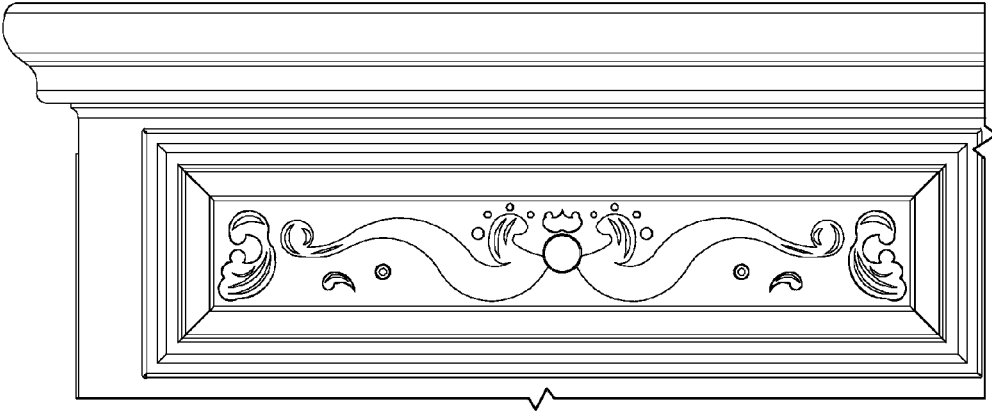

FIG. 8

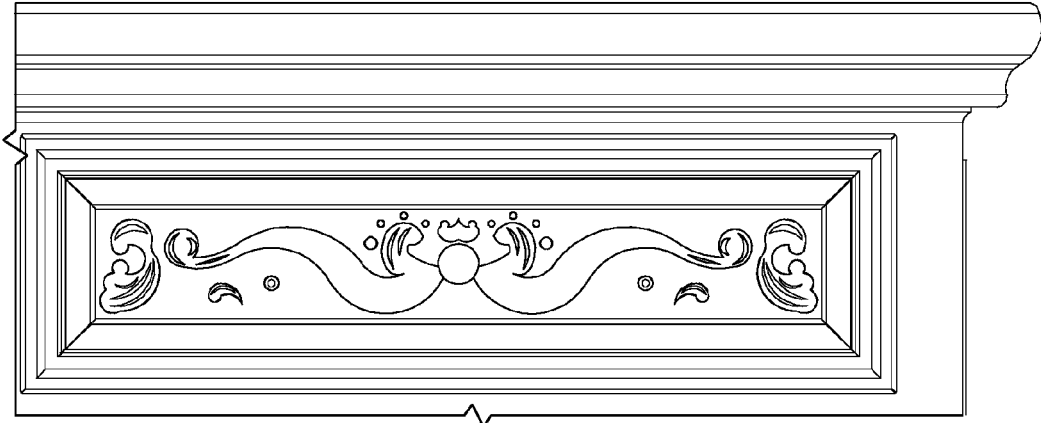

FIG. 9

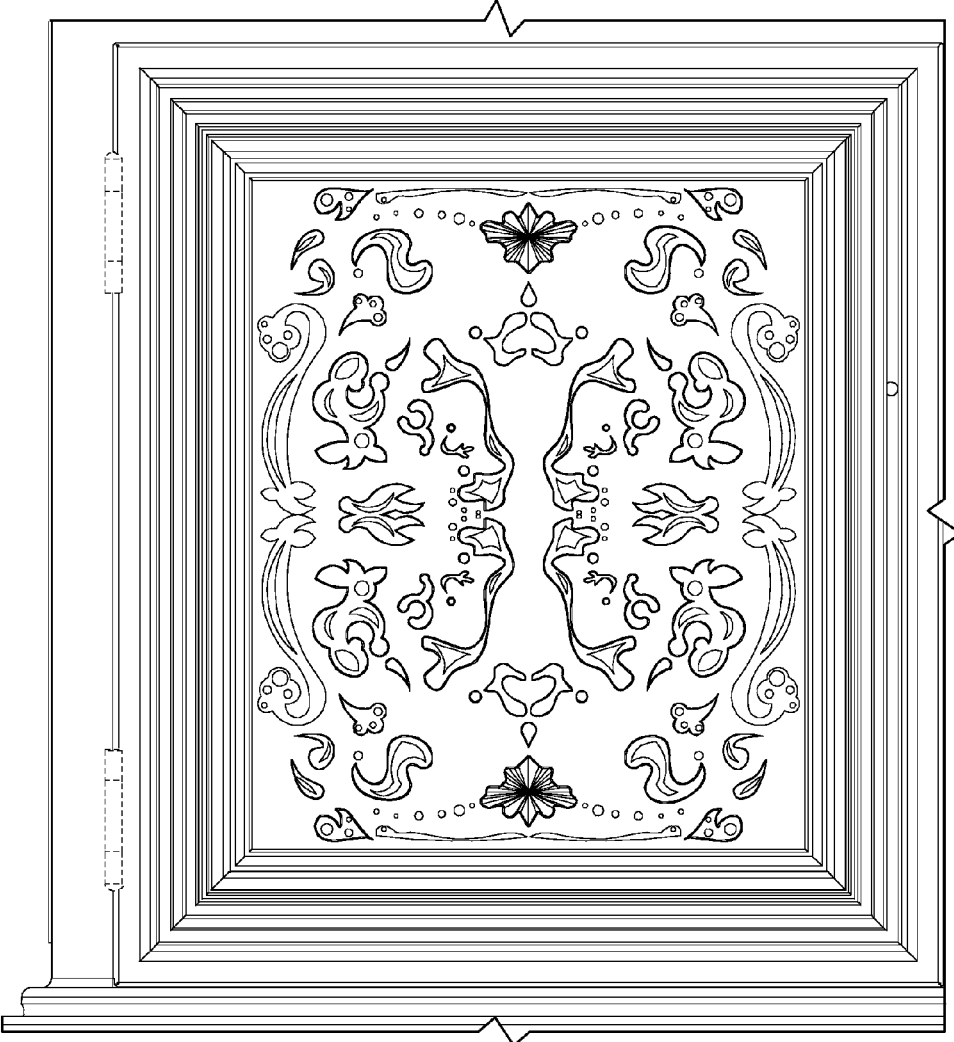

FIG. 10

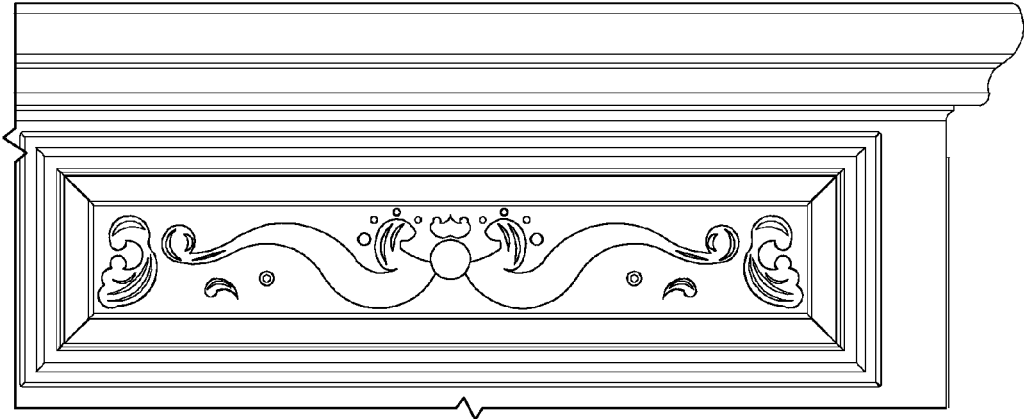

FIG. 11

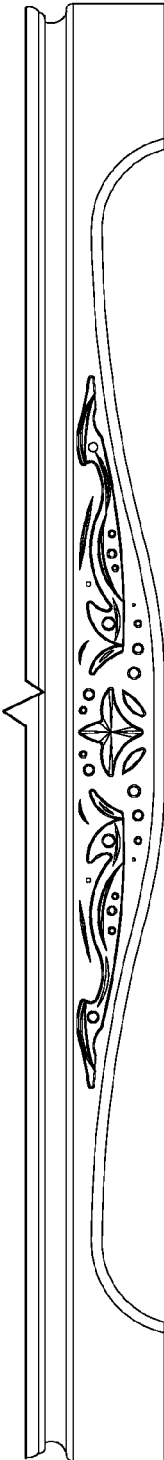

FIG. 12

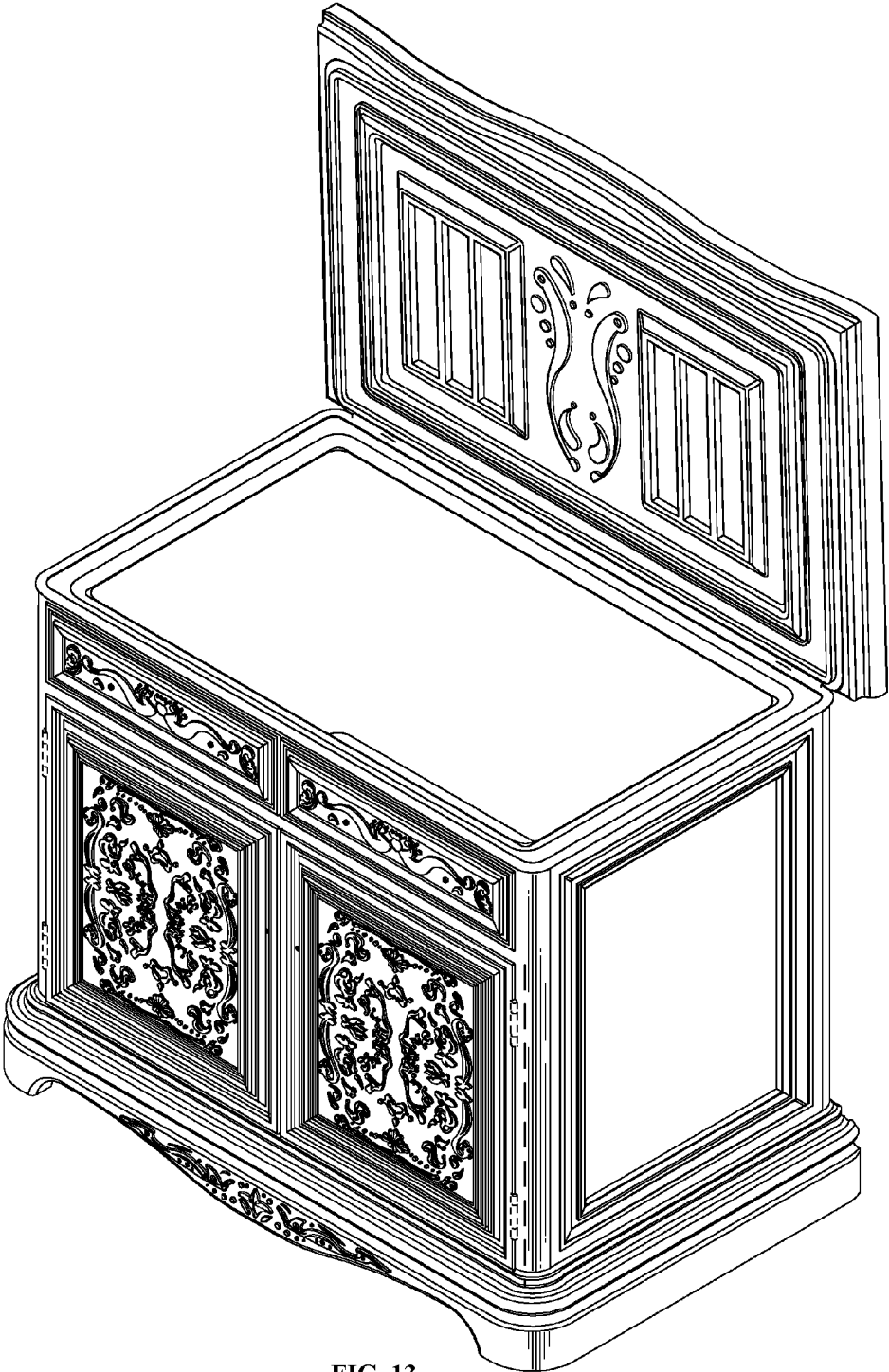

FIG. 13

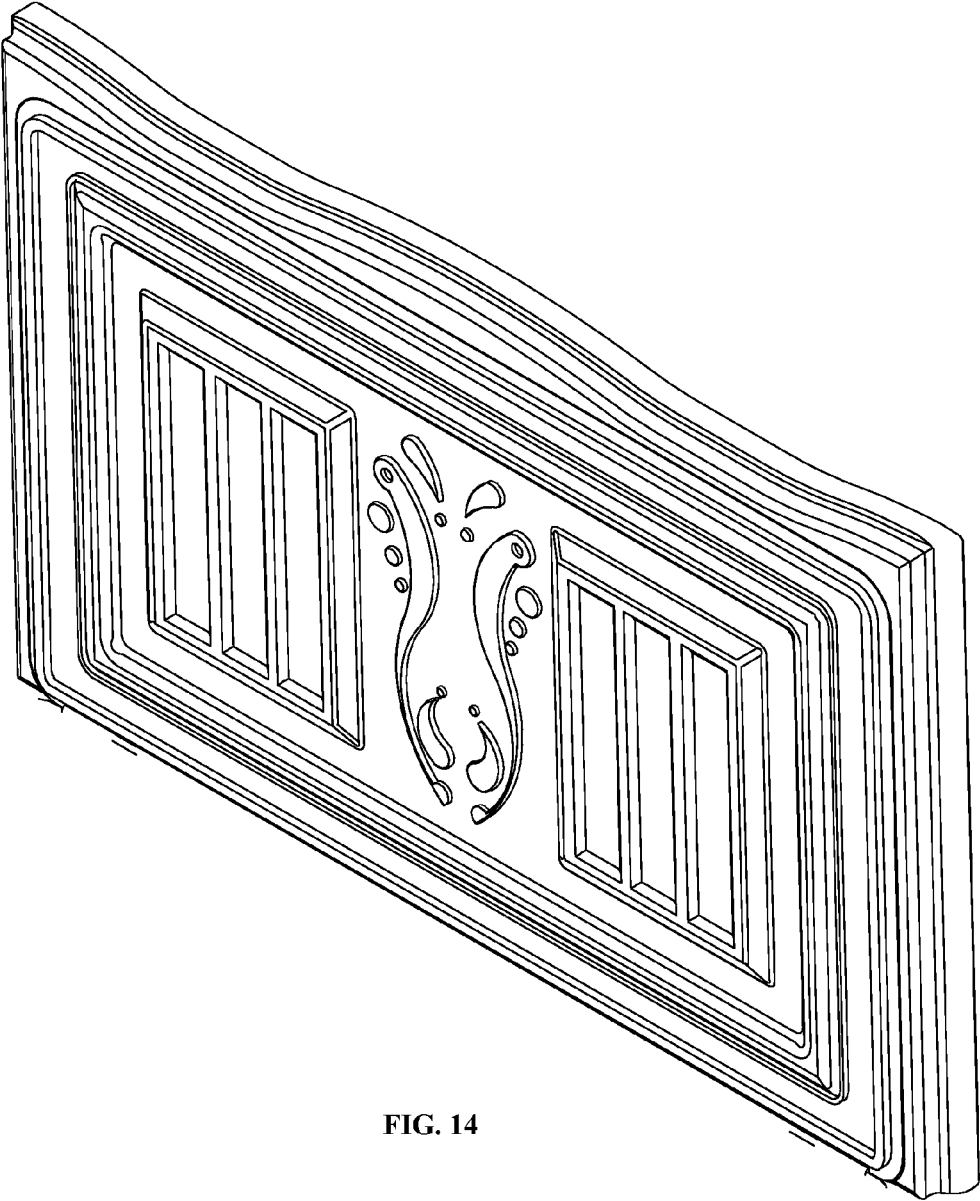

FIG. 14

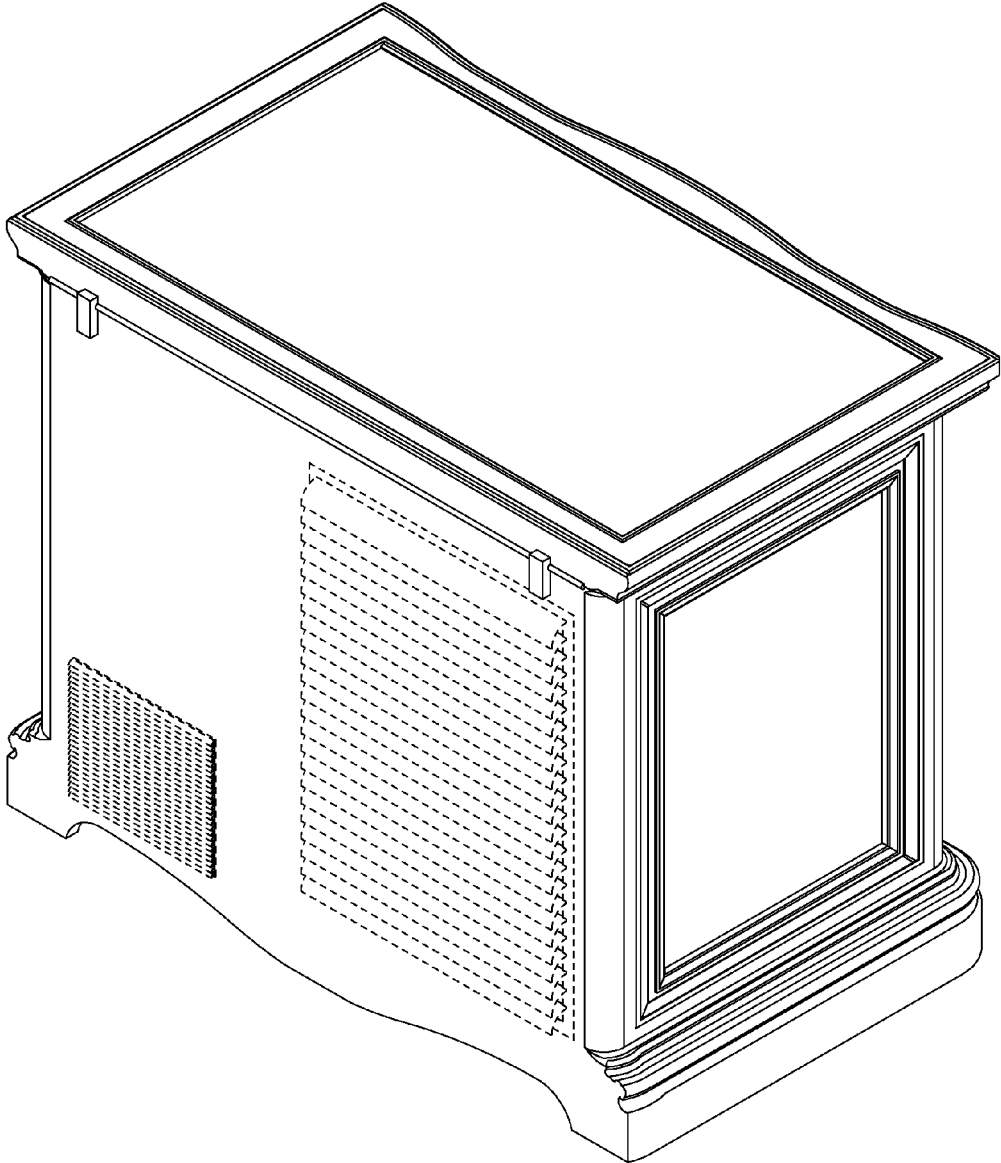

FIG. 15

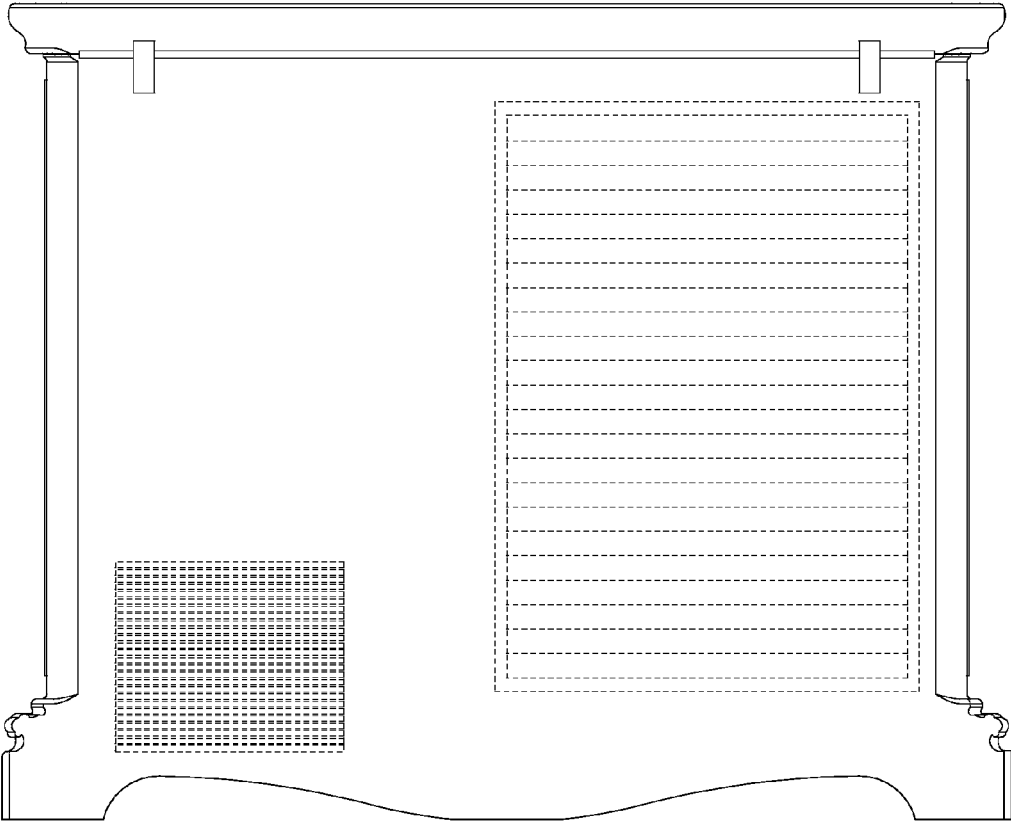

FIG. 16

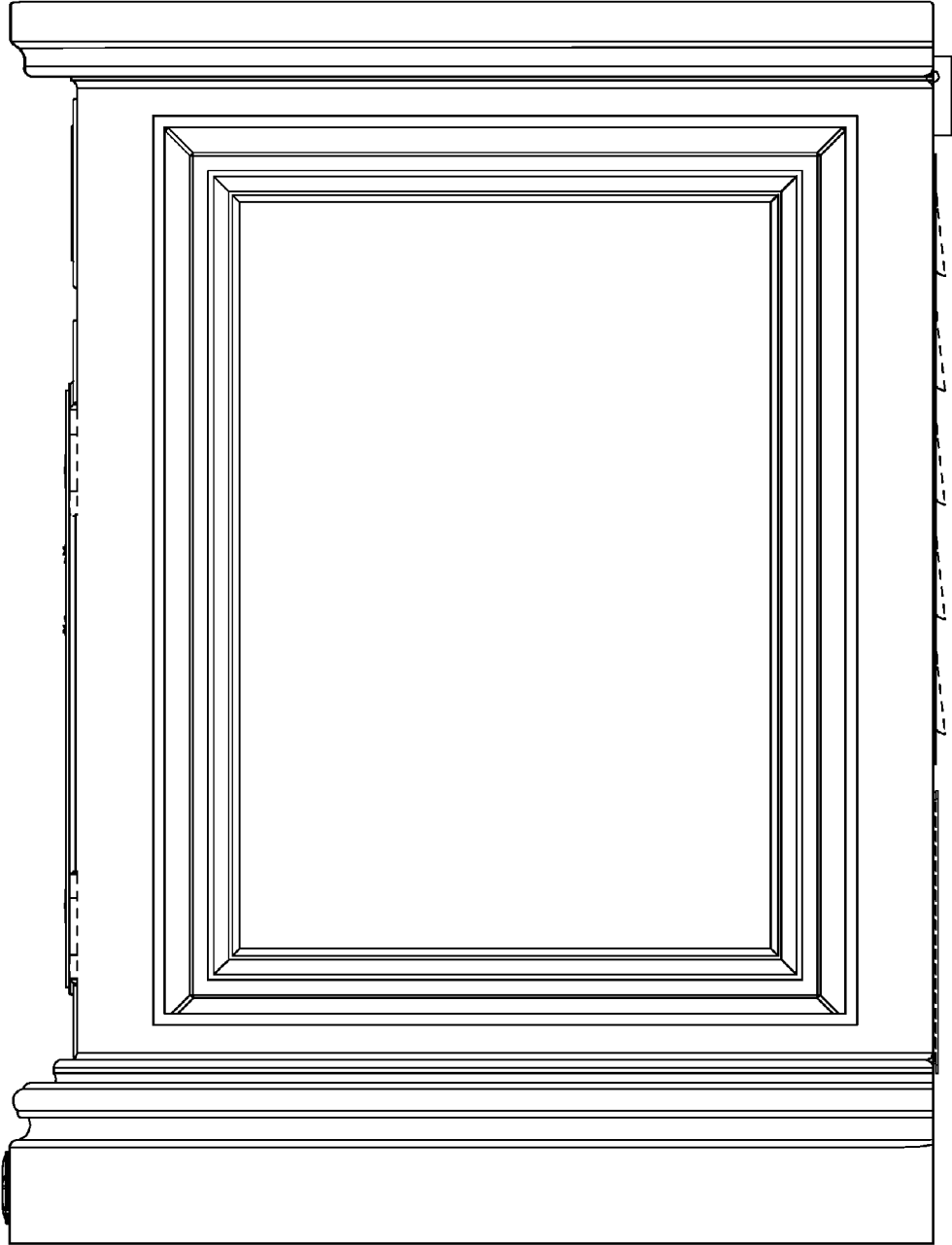

FIG. 17



FIG. 18

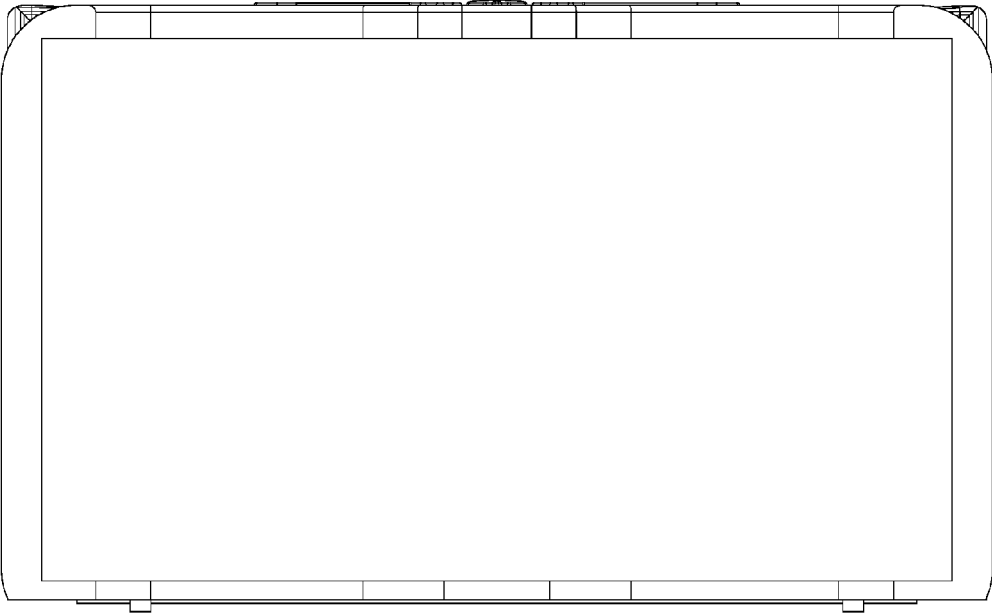

FIG. 19

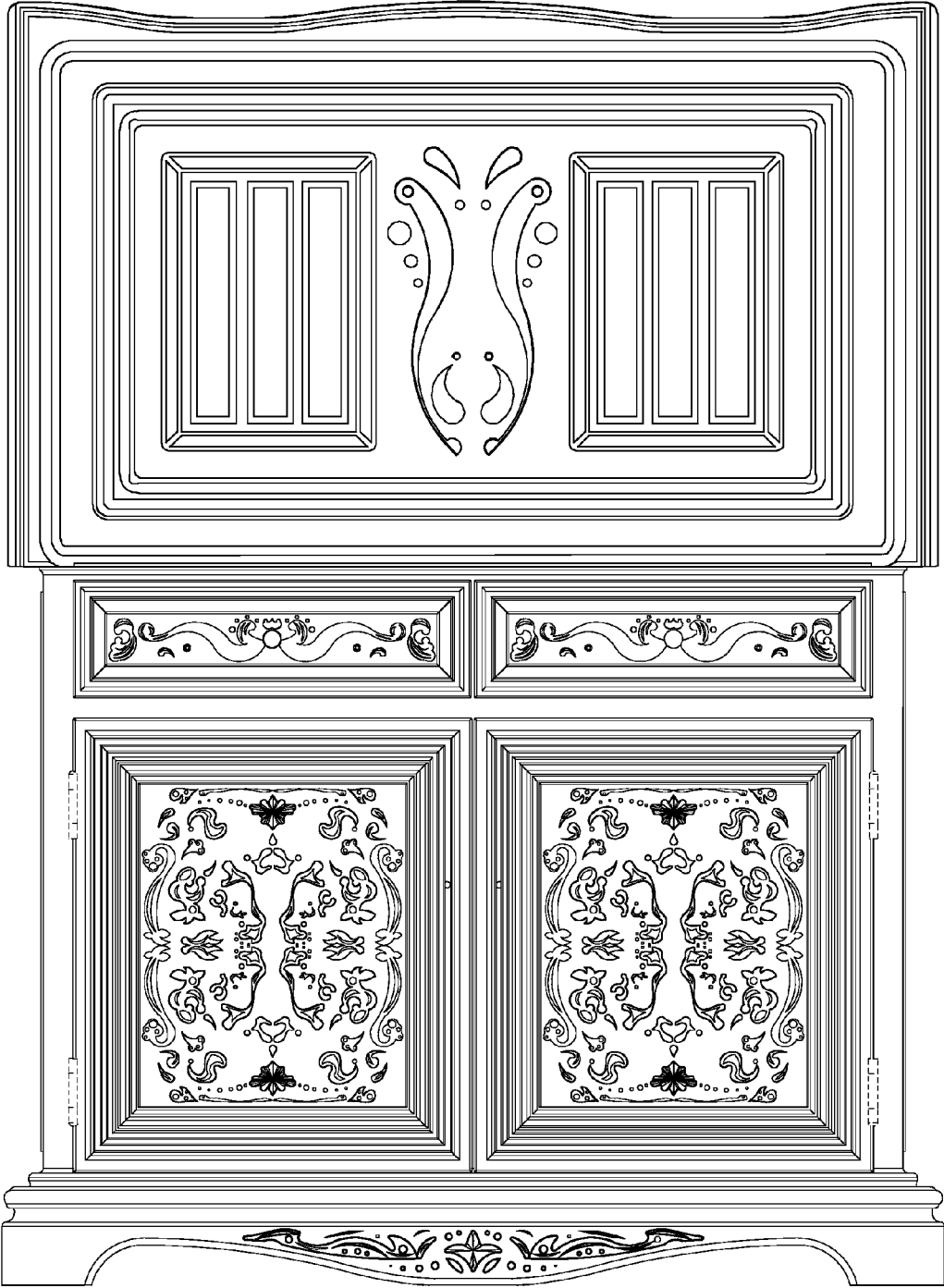

FIG. 20

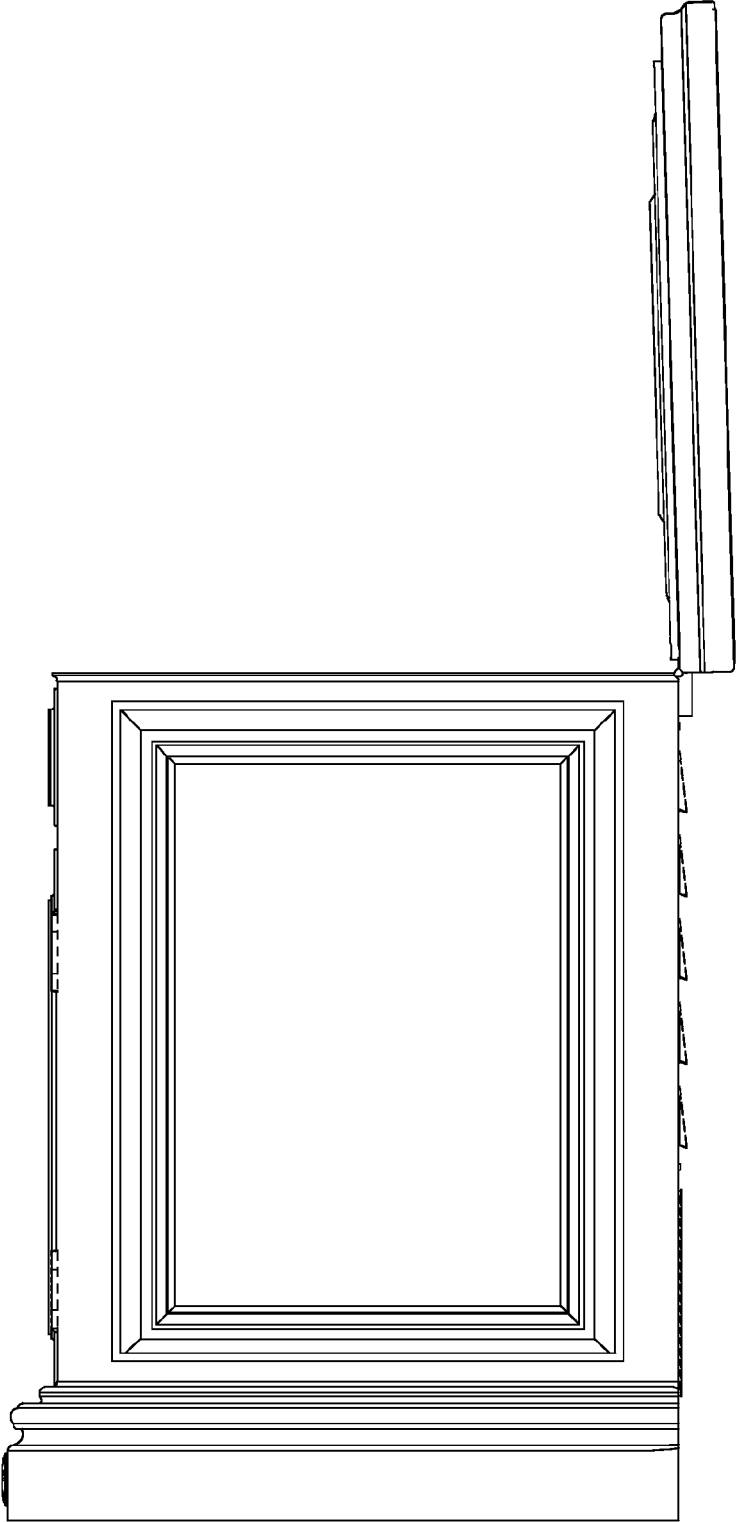

FIG. 21

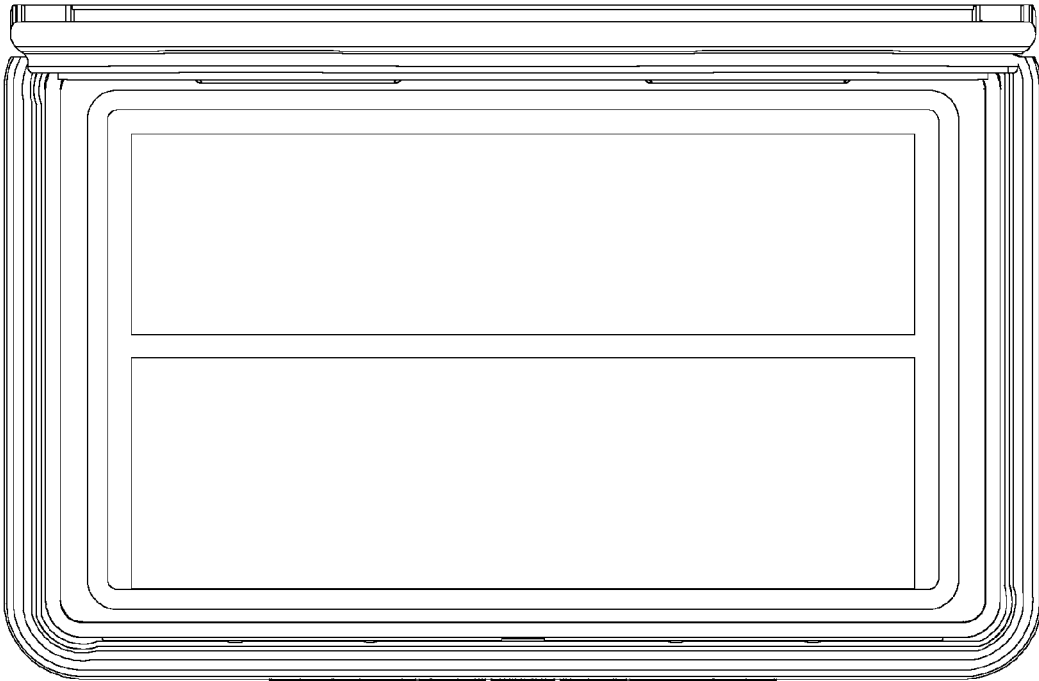

FIG. 22